

A-A (1 : 13)

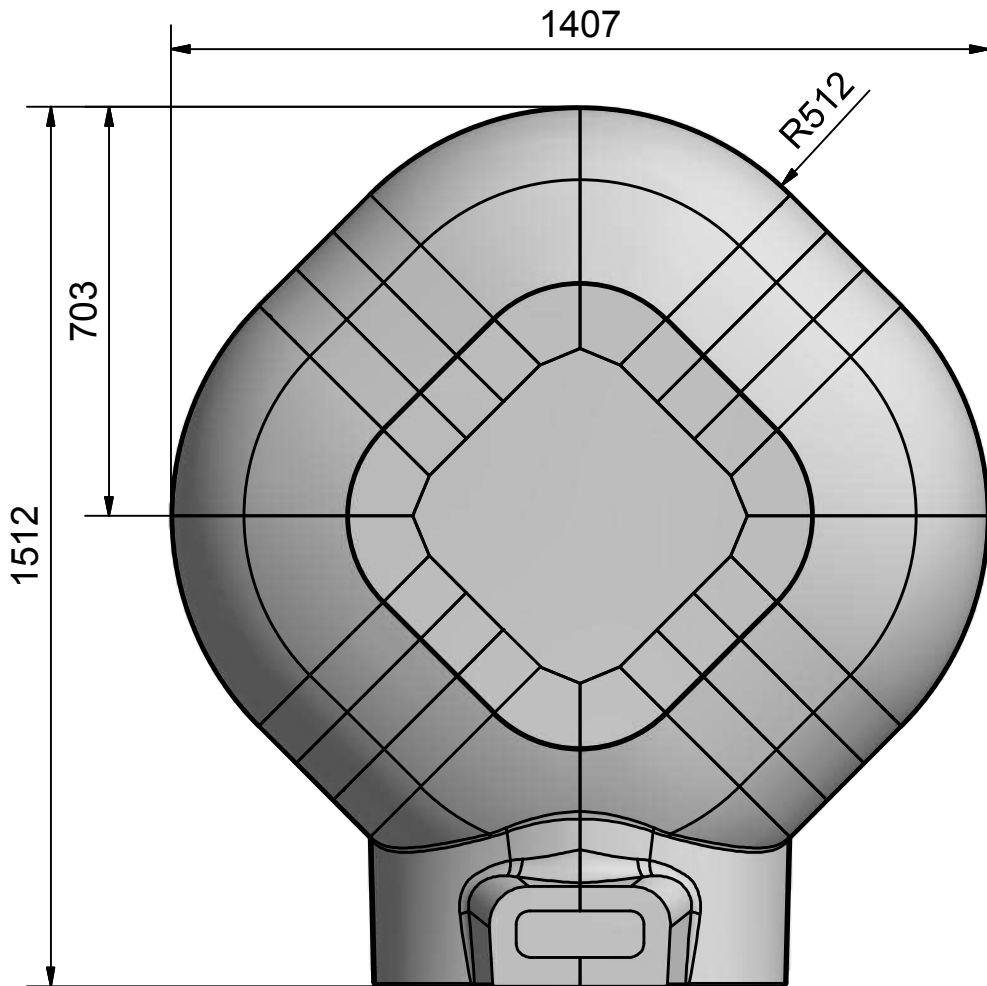

Pizzaofen Größe 4